

OPERATING INSTRUCTIONS

Evaporative humidifier

B 260



PLEASE READ THESE OPERATING INSTRUCTIONS CAREFULLY BEFORE STARTING ANY WORK!



Use and storage of the manual

Read these instructions carefully before operating the Brune B 260 Evaporative Humidifier. Failure to observe these instructions may result in injury, damage to the humidifier or to the equipment of the installation site. Keep the instructions carefully and accessible near the unit. If you pass the humidifier on to third parties, please also include the operating instructions.

Illustrations in this manual are for basic understanding and may differ from the actual design.

Note on commissioning

A prerequisite for safe working is compliance with all the safety instructions and handling instructions given. To put the humidifier into operation, it must be connected to the mains and the water tank must be filled (↳ see chapter "3.2 Preparing the humidifier for operation" on page 12).

The optional connection of the humidifier to the water supply system must be carried out by qualified plumbers.

Note on cleaning and care

To ensure optimal operation, the evaporative filter disc and the cleaning filter must be changed regularly. To avoid creating conditions favourable for germ formation, regular water changes and cleaning of the water tank as well as the inside walls of the appliance are necessary (↳ see chapter "4. Cleaning and maintenance" on page 20).

Accessories

The following accessories are available for the Brune B 260 evaporative humidifier from Brune Luftbefeuchtung Proklima GmbH:

- Pressure hose with Aquastop (only for units with direct water connection) / item no.: 1754
- Safety collection reservoir / item no.: 2160
- Waterfresh / item no.: 9020, 9022
- Limescale remover / item no.: 9016
- Cleaning filter / item no.: 2624
- Evaporation filter disc / item no.: 2625
- Automatic water feed/supply (direct water connection/AWS) / item no.: 2286
- Water monitor (only for units with direct water connection) / item no.: 1753
- Radio humidity transmitter (optional) / item no.: 1348/5
- WLAN/Wifi module (optional) / item no.: 2510

Copyright protection

The contents of this manual are protected by copyright. Their use is permitted within the scope of use of the unit. Any other use is not permitted without the written consent of Brune Luftbefeuchtung Proklima GmbH.

Customer service

Address BRUNE
 Luftbefeuchtung Proklima GmbH
 Schwarzacher Straße 13
 D-74858 Aglasterhausen

Phone +49 (0) 6262 / 54 54
Fax +49 (0) 6262 / 32 55

E-mail mail@brune.info

Table of contents

1. Product description	4
1.1 Humidifier overview	4
1.2 Operating and display elements	5
1.3 Technical data	6
2. Security	7
2.1 Symbols in this manual	7
2.2 Intended use	7
2.3 Hazards posed by the humidifier	8
2.4 Environmental protection	10
3. Transport and commissioning	11
3.1 Transport and set up	11
3.2 Prepare the humidifier for operation	12
3.3 Putting the humidifier into operation	13
3.4 Putting the radio humidity transmitter into operation (optional accessory)	14
3.5 Encode radio humidity transmitter	16
3.6 Wlan / Wifi module	17
4. Cleaning and care	20
4.1 Maintenance table	20
4.2 Open and close the intake and discharge grilles	20
4.3 Change water and clean the unit	21
4.4 Change evaporation filter disc	21
4.5 Change cleaning filter	23
5. Menu overview	24
6. Fix problems	25
7. Spare parts	26
8. Nameplate	26
9. Disposal	26

1. Product description

1.1 Humidifier overview

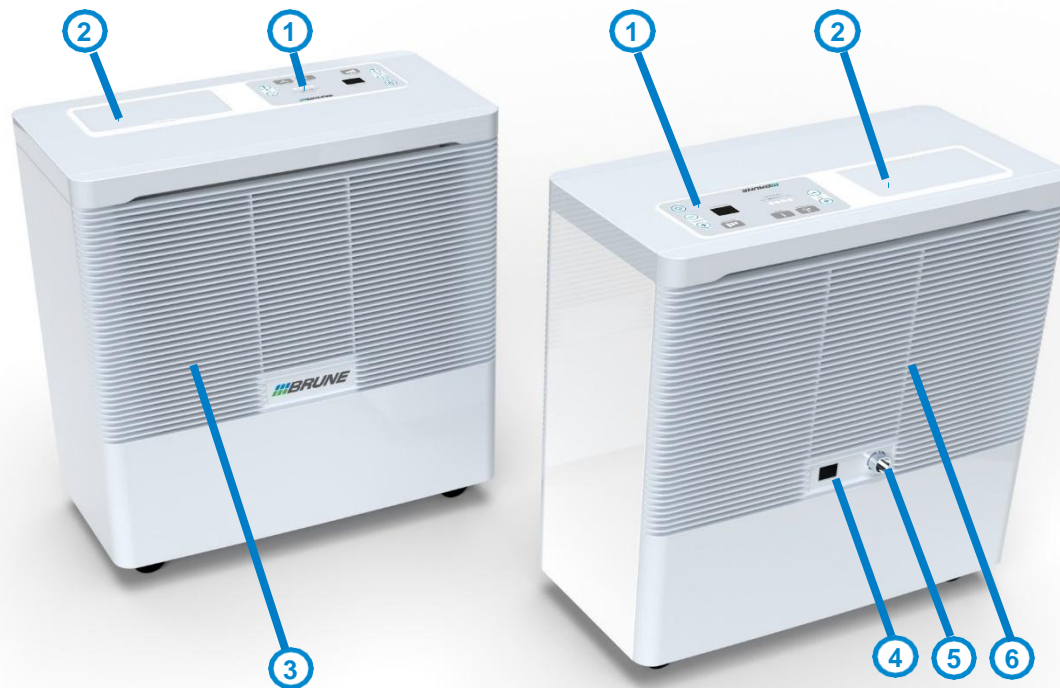

Fig. 1.1.1: Overview humidifier (left: front view; right: rear)

- 1. Control panel
- 2. Filler flap
- 3. Air outlet grille

- 4. Connection socket mains cable
- 5. Solenoid valve water connection
- 6. Intake grille

Function



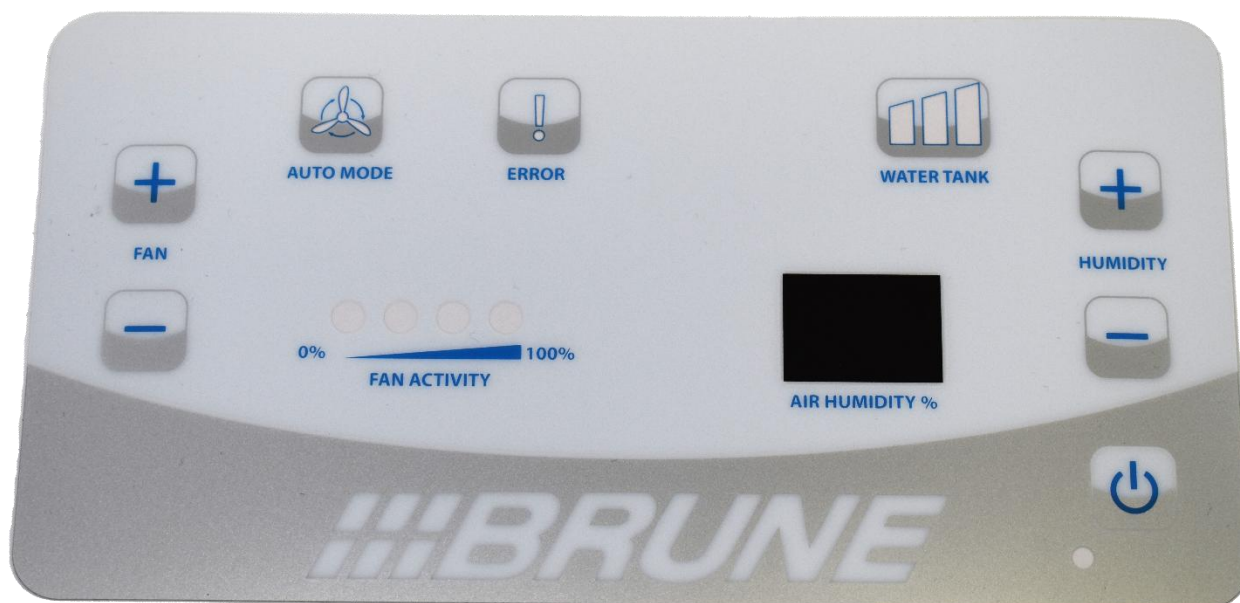

The humidifier works on the principle of evaporation. This means that the evaporation filter disc inside the water tank rotates and absorbs the moisture during this process. The fan draws in the ambient air through the intake grille, filters it through the cleaning filter and blows the air through the rotating evaporation filter disc whereby the air is being humidified. The cleaned and humidified air is then discharged back into the room through the outlet grille.

1.2 Operating and display elements





Operation



Operating elements

Symbol	Description	Operation
	FAN +	■ Increase the fan speed.
	FAN -	■ Reduce the fan speed. ■ Lowest level: Switch on automatic mode.
	HUMIDITY +	■ Increase the target value of the relative humidity.
	HUMIDITY -	■ Reduce the set value of the relative humidity.
	STANDBY / ON / OFF	■ Switch on the humidifier. ■ Switch to standby mode. In standby mode, the red LED lights up.

Display elements

Symbol	Description	Display
	AUTO MODE	■ Red: Automatic mode running ↪ see "Automatic mode fan" on page 13
	ERROR	■ Red: An error has occurred ↪ see "Error code display" on page 25
	WATER TANK	<ul style="list-style-type: none"> ■ Red LED flashes: Tank empty ↪ see chapter "4.3 Changing the water and cleaning the device" on page 21 ■ Red LED lights up: water level sufficient for operating ■ 1.Green LED lights up: tank halfway full ■ 2.Green LED lights up: Tank full. Stop filling.
	FAN ACTIVITY	■ Current fan speed level ↪ see "Setting the fan speed" on page 13
	AIR HUMIDITY %	■ Actual value of relative humidity
	AIR HUMIDITY % with the HUMIDITY + or HUMIDITY - key held down	■ Setpoint value of the relative air humidity
	AIR HUMIDITY % with simultaneous illumination of the ERROR display	■ Error numbers ↪ see "Error code display" on page 25

1.3 Technical data

Indication	Value	Unit
Weight (empty)	18,4	kg
Wide	600	mm
Height	670	mm
Depth	310	mm
Tank volume	approx. 20	l
Mains connection	220-240	V
Mains frequency	50/60	Hz
Power consumption	65	W
Maximum water pressure when connected to water main	0,2 - 8	bar

Operating conditions

Indication	Value	Unit
Temperature	10 - 40	°C
Relative humidity	20 - 90	%

2. Security

This section provides an overview of all important safety aspects for the protection of persons and for safe and trouble-free operation. Further task-related safety instructions are contained in the sections on the individual life phases.

2.1 Symbols in this manual

Safety instructions

Safety instructions are identified in these instructions by symbols. The safety instructions are introduced by signal words that express the extent of the hazard.

**DANGER!**

This combination of symbol and signal word indicates an imminently hazardous situation which, if not avoided, will result in death or serious injury.

**DANGER!****Danger to life due to electric current!**

This combination of symbol and signal word indicates an imminently hazardous situation which, if not avoided, will result in death or serious injury from electrical current.

**WARNING!**

This combination of symbol and signal word indicates a possibly dangerous situation which can lead to death or serious injury if not avoided.

**NOTE!**

This combination of symbol and signal word indicates a potentially hazardous situation which, if not avoided, may result in environmental and property damage.

2.2 Intended use

The B 260 evaporative humidifier is intended exclusively for humidifying and purifying room air in a private environment and is not suitable for use in the medical sector.

Intended use also includes compliance with all the information in these instructions.

Any use beyond the intended use or any other use is considered misuse.

Hygienic operation

When operated with clean fresh drinking water and in accordance with this manual, the unit is safe to use for domestic humidification. However, drinking water contains bacteria and microorganisms. To ensure hygienic and proper operation of the humidifier, regular water exchange and cleaning is essential. If this is not observed, it may cause health problems under certain circumstances. Therefore, always follow the cleaning instructions and keep your appliance clean and fresh.

Misuse



WARNING!

Danger in case of misuse!

Misuse of the evaporative humidifier B 260 can lead to dangerous situations, damage to the unit or to furnishings.

- Fill humidifier only with fresh ordinary tap water (max. 150 CFU/ml).
- Do not add essential oils or other flammable liquids.
- Only use additives approved by Brune Luftbefeuchtung Proklima GmbH.
- Do not use fragrances or flavourings.
- Never cover the appliance.
- Never place objects on the humidifier. This applies in particular to electrical appliances or containers filled with liquid.
- Do not climb onto or sit on the unit.
- Do not transport any objects with the appliance.
- Do not use humidifiers in rooms with air polluted by dust, microbes or chemicals.

2.3 Hazards posed by the humidifier

The humidifier is built according to the state of the art and current safety requirements. Nevertheless, residual dangers remain that require prudent action. The residual dangers and the resulting behaviour and measures are listed below.

Electric current



DANGER!

Danger to life due to electric current!

Contact with live parts of the power supply unit poses an immediate danger to life due to electric shock. Damage to the insulation or individual components can be life-threatening.

- Keep moisture away from live parts. It can lead to a short circuit.
- Always disconnect the mains plug before cleaning and troubleshooting.
- Never immerse the unit in water.
- Never point the outlet at electrical appliances or sockets.
- Never touch the mains plug with wet hands. When pulling the mains plug, always pull on the plug, never on the cable.
- Always lay the mains cable so that it cannot come into contact with sources of heat, moisture, oil, sharp objects, sharp edges, etc.

Special groups of people and children



WARNING!

Danger for special groups of people and children!

This appliance is not intended to be used by persons (including children) with reduced physical, sensory or mental capabilities, or lack of experience and/or knowledge.

- Supervise children to ensure that they do not play with the appliance.
- Packaging materials must not be used for play. There is a danger of suffocation.
- Keep batteries away from children.

Poor cleaning



WARNING!

Health hazard due to inadequate cleaning!

Poor cleaning can release bacteria and germs.

- Replace the evaporation filter disc after three months at the latest.
- Always follow the time intervals for cleaning, filter change and water change described in chapter "4. Cleaning and maintenance" on page 20.
- If the room air and water are heavily contaminated, shorten the time intervals accordingly.

Overhumidification



WARNING!

Health hazard due to overhumidification!

Over-humidified air promotes the formation of mould and harmful germs.

- In living rooms, do not exceed the recommended value of 50 - 60 % humidity.
- To prevent damage to health, persons with asthma, respiratory diseases or lung problems should consult a doctor before using the humidifier.
- Do not place the appliance near furnishings that absorb water, such as curtains, wallpaper and carpets.

Batteries (only for radio units/ not included in the scope of delivery)



WARNING!

Risk of injury if batteries are handled incorrectly!

If batteries are handled incorrectly, there is a risk that the batteries will explode or that harmful liquid will leak from the batteries. The liquid can cause skin burns if it comes into contact with the skin, severe poisoning if swallowed and blindness if it comes into contact with the eyes.

- Never attempt to charge batteries.
- Never short-circuit the contacts (positive and negative pole) of the battery.
- Never expose batteries to wetness or moisture (rain, salt water, liquids). A damp or wet battery must never be used.
- Never use or store batteries in places where there is an explosive atmosphere or where high temperatures may occur.
- Never attempt to solder, repair, alter the shape, rebuild or disassemble batteries.
- Always protect batteries from access by unauthorised persons.
- To avoid fire, overheating, explosion or liquid leakage, never subject batteries to violent shocks, heavy loads or other harmful effects. Leaking liquid may ignite.
- After eye contact with spilled liquid, rinse the eye immediately with clean water for at least 15 minutes, also under the eyelid. Direct a mild stream of water directly into the eye and do not rub. Seek medical attention immediately.
- Avoid skin contact with spilled liquid. In case of accidental skin contact, wash affected skin area with plenty of soap and water.

Unsuitable installation site



NOTE!

Risk of property damage due to incorrect placement of the humidifier!

- Only set up the humidifier on level, sufficiently load-bearing and moisture-resistant floors.
- Do not place the appliance near furnishings that absorb water (e.g. curtains, wallpaper, carpets).

2.4 Environmental protection



NOTE!

Danger to the environment due to incorrect handling of environmentally hazardous substances!

Incorrect handling of environmentally hazardous substances, especially incorrect disposal, can cause considerable damage to the environment.

- Always observe the instructions below on handling and disposing of environmentally hazardous substances.

Batteries

Batteries contain toxic heavy metals. They are subject to hazardous waste treatment and must be handed in at municipal collection points or disposed of by a specialist company.

3. Transport and commissioning

3.1 Transport and set up

- Only set up the humidifier on level, sufficiently load-bearing, moisture-resistant floors.
- Ensure that the circulation of the air is guaranteed. Intake and discharge grilles must not be covered.
- The distance to other objects in the vicinity must be at least 10 cm at the sides and at least 20 cm above.
- For optimal function, the unit can be placed near a heat source. However, the direct exposure to temperature should not exceed 50 °C.

For water-sensitive floors, we recommend the use of a safety drip tray (item no.: 2160).

Move humidifier



NOTE! Risk of material damage due to tipping of the humidifier!

If the humidifier is moved, there is a risk of the unit tipping over. This can cause damage to the unit or the floor.

- Move the humidifier along the longitudinal axis whenever possible (Fig. 3.1.1).
- Always empty the water tank before changing location.

The humidifier has four castors on the bottom. To change the location of the unit, it can be pushed or pulled.

Fig. 3.1.1: Move humidifier

Lift humidifier



WARNING!
Danger when lifting the humidifier!

- Always empty the water tank before changing location.
- Only lift the humidifier two at a time.

3.2 Prepare the humidifier for operation

Connection socket Mains plug



Fig. 3.2.1: Rear side with connection socket





Damaged connection cable!

If the mains connection cable of this unit is damaged, it must be replaced by a special connection cable! This can be obtained from the manufacturer or your customer service.

1. Check the connection cable for damage.
2. Connect the mains plug to the connection socket (Fig. 3.2.1/1) on the humidifier.
3. Connect the unit to the mains.
4. Switch on the unit (↵ see chapter "3.3 Starting up the humidifier" on page 13).

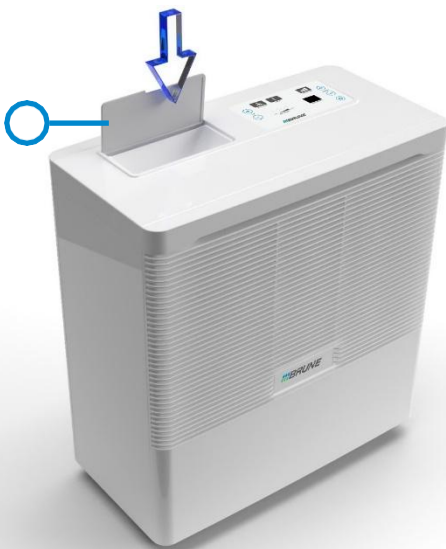
Fill water tank



1. Open the filler flap (Fig. 3.2.2/1).
2. Fill with water until the indicator  WATER TANK turns green. As soon as the indicator  WATER TANK lights up green stop filling immediately.
3. Close the filler flap.



NOTE!

Risk of material damage due to overfilling the humidifier!

The water tank is in danger of overflowing if the WATER TANK indicator  lights up green and the tank is still being filled.

Fig. 3.2.2: Filling the water tank

Waterfresh (optional accessory)

Waterfresh can additionally be filled into the water tank to reduce germ and algae formation as well as limescale deposits. Observe the dosage, usage and disposal instructions given on the packaging of Waterfresh. The water freshener can be obtained from our customer service (↵ "Customer service" on page 2).

Item no.: 1l bottle: 9020; 5l canister: 9022;

- Use biocides safely.
- Obtain information on environmentally friendly disposal from the local authority or special waste management companies.
- Always read the label and product information before use.
- Safety data sheet can be requested.



NOTE!

Environmental damage due to biocides!

The biocides contained in Waterfresh are harmful to the environment in larger quantities.

Water connection (optional accessory)



As an alternative to filling the water tank manually, the humidifier can be connected to the water network by means of an automatic water supply. To do this, have the humidifier connected via the solenoid valve on the back exclusively by sanitary specialists.

Additional safety accessories

To reduce the risk of property damage, the following safety accessories are recommended:

- Safety collection reservoir (item no.: 2160).
- Pressure hose with Aquastop (only for units with direct water connection, item no.: 1754).

3.3 Putting the humidifier into operation

Switch on humidifier	Press the STANDBY button  . + Humidifier is switched on.
Standby	Press the STANDBY button  . + Humidifier is on standby. In standby mode, the red LED lights up.
Switch off	To safely switch off the humidifier, during maintenance or long-term standstill: + Pull the plug & disconnect the humidifier from the mains.

Overhumidification



WARNING!



Health hazard due to overhumidification!

Over-humidified air promotes the formation of mould and harmful germs.

- In living rooms, do not exceed the recommended value of 50 - 60 % humidity.

Set relative humidity

The target value of the relative humidity can be set in the range from 20 % to 90 %.

- + Use the HUMIDITY  and HUMIDITY  buttons to set the desired target value for the relative humidity.
→ The AIR HUMIDITY % display  shows the selected value.

Set fan speed

The air flow rate and thus the humidifier capacity can be adjusted via the fan speed, for example: Select a higher speed level for large rooms.



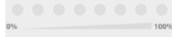

- + Use the FAN  and FAN  buttons to set the desired fan speed level.

→ The FAN ACTIVITY display  shows the selected speed level.





→ The humidifier runs at the selected fan speed until the selected target value of relative humidity is reached.

Automatic mode fan





In automatic mode, the humidifier automatically regulates the fan speed according to the power requirement until the desired value of relative humidity has been reached.

1. Select the setpoint value of the relative humidity with the HUMIDITY  or HUMIDITY  keys.
2. Press the FAN button  repeatedly until the AUTO MODE indicator lights up.
+ Automatic mode is switched on.
+ To exit automatic mode, press the FAN button  once and accept the changed settings.

Switching the key lock on and off

1. To switch on the key lock, press the HUMIDITY  and HUMIDITY  keys until the display shows "88" appears.
+ The key lock is activated.
2. To switch off the key lock, press the HUMIDITY  and HUMIDITY  keys simultaneously until the display shows "88" goes out.
+ The key lock is switched off.

Activation/deactivation of the signal tone

Switch off the unit with the standby key . Now press the standby key  and keep it pressed for five seconds until "Add"  appears on the display. Press the FAN key  to switch to the submenu for "b1/b0". By pressing the HUMIDITY key  you can activate (b1) or deactivate (b0) the signal tone.

Once the setting has been made, exit the menu by pressing the standby button .

3.4 Putting the radio humidity transmitter into operation (optional accessory)

Humidity measurement

The radio humidity transmitter (item no.: 1348/5) measures the relative humidity in the room and transmits it by radio to the humidifier. This enables a more accurate measurement than by using the built in sensor of the unit, which may produce deviating measurement results due to the humidity inside the unit.



It is recommended to use a radio humidity transmitter into operation when exact control of the relative humidity is required.

Putting the radio humidity transmitter into operation



1. Carefully lift the cover of the radio humidity transmitter with a small screwdriver and remove it (fig. 3.4.1).

Fig. 3.4.1: Opening the cover

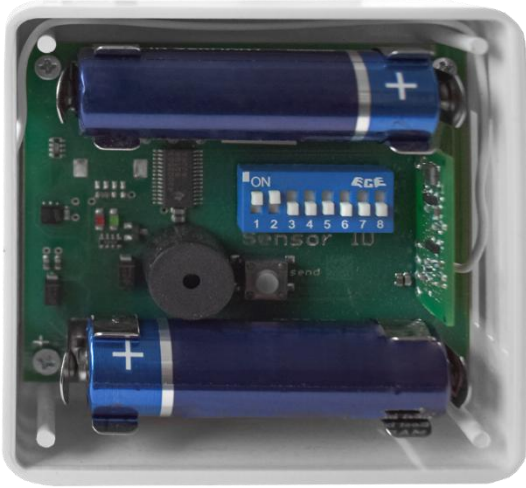

Fig. 3.4.2: Insert batteries

2. Insert the 1.5 V AA batteries as shown (fig. 3.4.2). The plus and minus poles are marked on both the circuit board and the battery. The batteries are correctly inserted when these markings match.



ATTENTION

The required batteries are not included in the scope of delivery!
Batteries required: 2 x AA 1.5 V

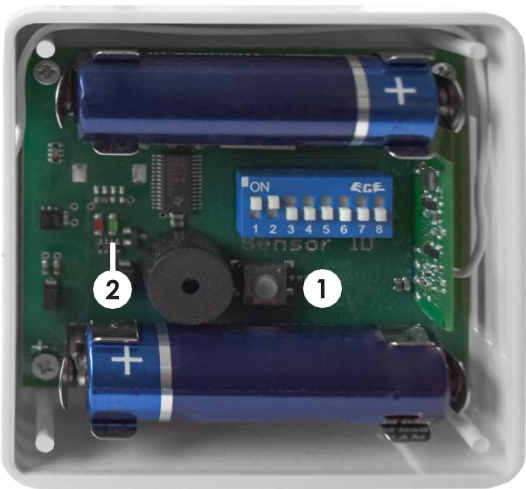



Fig. 3.4.3: Check functionality

3. Check the radio humidity transmitter for functionality. To do this, press the button (fig. 3.4.3/1).
 - + When the LED (fig. 3.4.3/2) lights up briefly, the radio damp-transmitter is ready for operation. If the radio transmitter emits a short signal tone at regular intervals during operation, replace the batteries.



It can take up to three minutes before the unit has received a signal from the radio humidity transmitter. The display shows "05" during this time.

- + The units are delivered from the factory with the coding "00".
- + The actual value of the relative humidity of the AIR HUMIDITY %  display changes as soon as you breathe into the sensor.

If the relative humidity value does not change, check batteries and coding.

Coding options

The humidifier and the radio humidity transmitter are matched to each other via a code. The units are delivered from the factory pre-coded. However, if two or more units are used in close proximity to each other (0 - 20 m), different coding may be necessary.

If several units are operated in one room, the following possibilities exist:

- Several units are operated with one radio humidity transmitter. For this purpose, all units must have the same coding.
- Each unit is controlled via a separate radio humidity transmitter. For this purpose, all units must be coded differently.

Encode radio humidity transmitter

The coding switch for coding is located on the circuit board of the radio humidity transmitter. There are only the positions "ON = up" and "OFF = down" per slider. The coding you have set can be read out on the unit.



The coding of the B 260 humidifier and the associated radio humidity transmitter must match exactly. Otherwise the function is not guaranteed.

3.5 Encode radio humidity transmitter





Fig. 3.5.1: Coding switch for coding



NOTE!
Material damage due to short circuit! Only code the radio transmitter with a non-metallic object.

1. Code the radio humidity transmitter by adjusting the sliders with a suitable non-metallic object.
2. Confirm the coding by pressing the small button. It can then be read out and selected on the unit.
3. Close the cover of the radio humidity transmitter again.

Select menu

In this menu you can choose many settings for your humidifier. You can find an overview of the possible settings on page 24 chapter 5 "Menu overview".

Switch the unit off with the standby button . Now press the standby button  and keep it pressed for 5 seconds until the display shows "Ad" .

By pressing the FAN button  you can now select the menu. With the HUMIDITY button  and  you can change the settings in the menus.

Coupling the radio humidity transmitter with the humidifier

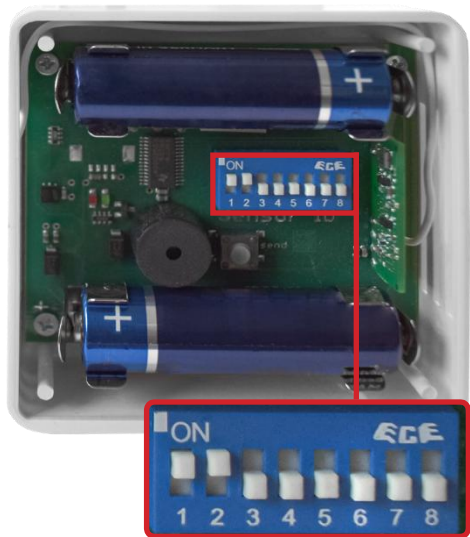



Fig. 3.5.2: Coding the humidifier

Menu Ad: This is where you pair the radio humidity transmitter with the device. You have a choice of 256 address codes here. The setting is made on the radio humidity transmitter using the 8-digit coding switch.

Use the HUMIDITY button  and  to select the desired radio coding.

For better orientation, radio humidity transmitters within range transmit their current coding to the unit. This is indicated by a short beep and two flashing dots in the display next to the address code.

Caution: If several radio humidity transmitters are within range, different codes are displayed.

Once the setting has been made, exit the menu by pressing the standby button .

3.6 Wlan / Wifi module

Switch on the humidifier B 260.

Search the network environment on the PC or search for "Brune WLAN" under Network & Internet settings (mobile device) and connect to it:



Now enter the IP address 192.168.4.1 in the web browser and open the start page of the network setup.

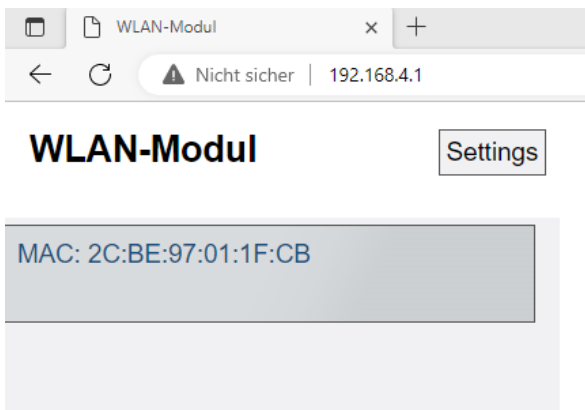

Click on "Settings" to open the menu for the WLAN configuration.

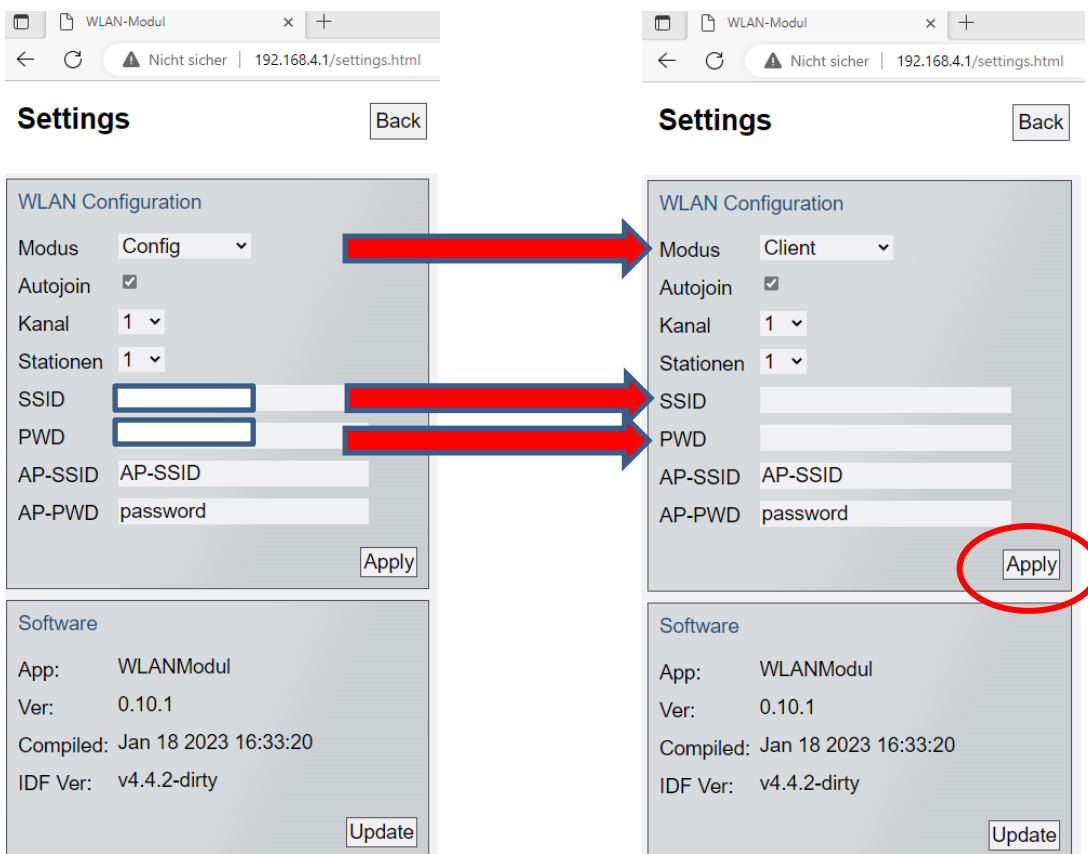

- 1.) The mode must be changed from "Config" to "Client".
- 2.) Enter the name of your WLAN network in the SSID field.
- 3.) Enter the corresponding password for your WLAN network in the PWD field.

Transfer all entries to the device with "Apply" to finalize.

The humidifier connects to your WLAN and receives a new IP address. You can now control your humidifier B 260 with the Brune Control APP (available for iOS and Android) or via the remote portal.



Brune Control
Lifestyle

LADEN



Activate Brune WLAN / reset network settings

Switch off the device by using the standby button. Now press the standby button and hold it down for 5 seconds until "Ad" appears on the display.

Press the FAN button to select the "n9" menu.

Press the HUMIDITY + and - buttons simultaneously to start a countdown to reset the settings.

ATTENTION!

Once the countdown is complete, all settings of the WLAN/WiFi module are deleted (display "n0").

To enable operation of the device via the remote portal, you must log in under <https://brune.remoteportal.de>. To do this, enter the labelled MAC address and the password below it in the login window.

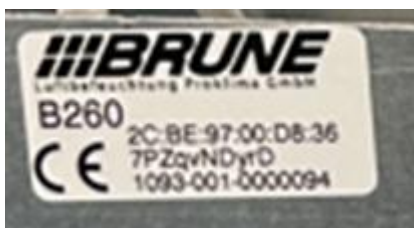

Anmelden

Benutzername oder MAC-Adresse:

Passwort:

automatische Anmeldung

Anmelden

The homepage of the remote portal opens and configurations can be made.

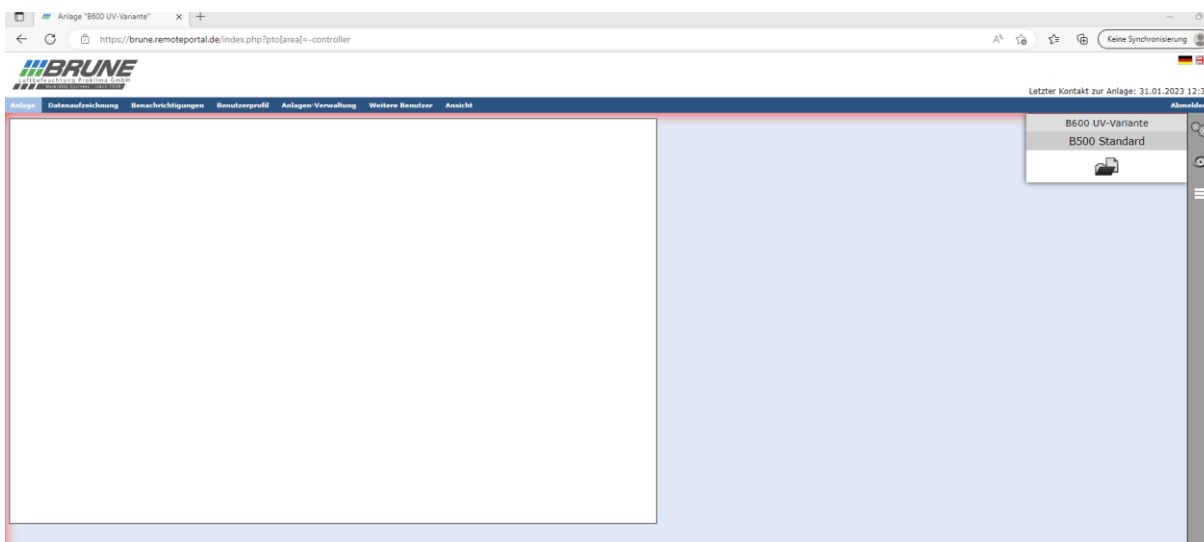

After registering, you can use the remote portal free of charge for 30 days via a trial account.

4. Cleaning and care

4.1 Maintenance table

Maintenance work

The frequency of maintenance depends on the air and water quality at the installation site. If necessary, adjust the maintenance intervals recommended here.



WARNING!
Disconnect the unit from the mains before carrying out maintenance work.



WARNING!
Risk of injury from moving parts! Rotating fan wheel can cause hand injuries.

Interval	Maintenance work
Weekly	Change the water and clean the tank (↪see chapter "4.3 Changing the water and cleaning the appliance" on page 21).
Monthly	Clean the inner side walls with a damp cloth (↪see chapter "4.3 Changing the water and cleaning the appliance" on page 21).
Every 3 months	Change the evaporation filter disk (↪see chapter "4.4 Changing the evaporation filter disk" on page 21). Change the cleaning filter (↪see chapter "4.5 Changing the cleaning filter" on page 23). Clean electrode rods for water level measurement (↪see Fig. 4.2.6 on page 22).
Every 6 months	Only for devices with direct water connection: Carry out a visual inspection of the solenoid valve to the water connection. Remove impurities. If the solenoid valve is very dirty, have it replaced by a plumbing specialist.
Annual	Carry out basic cleaning with limescale remover (↪see chapter "4.3 Changing the water and cleaning the appliance" on page 21).

4.2 Open and close the intake and discharge grilles

The outlet grille must be opened for the following work:

Change water, clean tank, clean electrode rods, clean inner side walls, change evaporation filter disk



Open the outlet grille

1. The air outlet grille of the humidifier is held in place by magnets and a catch on the upper side of the unit.
2. Lift the outlet grille on the underside of the unit. The outlet grille is fixed with several magnets (Fig. 4.2.1).
3. Now slide the outlet grille upwards to lift the component out of the lock on the unit.

Fig. 4.2.1: Removing the outlet grille

4.3 Change water and clean the unit

Use a limescale remover for cleaning in case of heavy soiling and limescale. You can obtain a suitable limescale remover from our customer service (↪ "Customer service" on page 2). Follow the dosage and application instructions on the limescale remover packaging (item no.: 9016).

1. Open the outlet grille (↪ see chapter "4.2 Opening and closing the intake and outlet grille" on page 20).
2. Pull out the water tank and the evaporation filter disc.
3. Empty the water tank.
4. Clean the water tank with a damp cloth.
5. Clean the inside walls of the humidifier with a damp cloth.
6. Insert the evaporation filter disc (↪ see "Fig. 4.2.7" on page 22).
7. Close the outlet grille (↪ see "Fig. 4.2.8" on page 22).
8. Fill the water tank (↪ see "Filling the water tank" on page 12).
9. Reset the water change reminder to delete the error message (↪ see 'Menu overview' on page 24).

NOTE!

Do not use abrasive, corrosive or soapy cleaners. May cause damage to the surface of the unit.

4.4 Change evaporation filter disc



Fig. 4.2.3: Pulling out the tank and evaporation filter disc

The matching evaporation filter disc (item no.: 2625) can be obtained from our customer service department (↪ "Customer service" on page 2).

ATTENTION: After completing the filter change, reset the number of days in the "FI" menu so that the error display disappears (↪ see "Menu overview" on page 24).

1. Open the outlet grille (↪ see chapter "4.2 Opening and closing the intake and outlet grille" on page 17).
2. Lift the tank from below and pull it out with the filter wheel facing forwards (Fig. 4.2.3).
3. Remove the evaporation filter disc upwards.

NOTE!

Caution: Danger of tipping over!

Risk of property damage due to escaping water.

- + When removing the water tank, make sure that the appliance does not tip over.

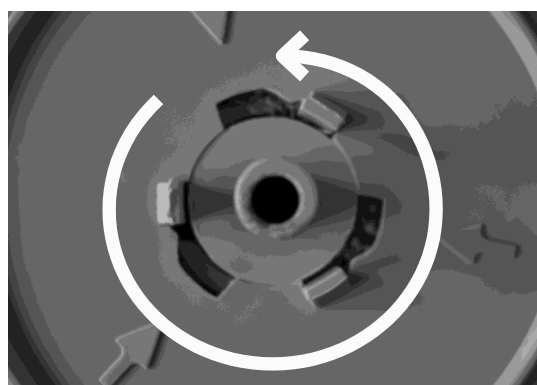

Fig. 4.2.4: Removing the filter retainer

4. Loosen the filter retainer (Fig. 4.2.4) in the middle of the filter (front and back of the filter disc) by pressing it and turning it slightly clockwise.

Important: Do not dispose of the filter retainer!

Put the filter retainer aside, as it will be needed again for the next step.

5. Now replace the evaporation filter disc (item no.: 2625).

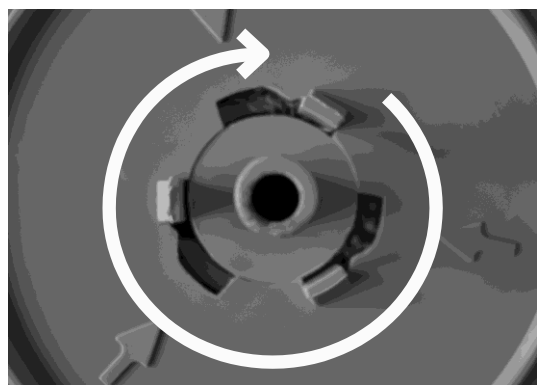

Fig. 4.2.5: Locking the filter retainer

6. Attach the filter retainer to the new evaporative filter disc. Please ensure that the filter retainer is correctly and securely in place, otherwise the filter could come loose during operation.



Fig. 4.2.6: Electrode rods for water level measurement

7. Check the electrode rods for water level measurement (Fig. 4.2.6/1) for dirt. If necessary, remove limescale and other residues with a cloth or sponge.

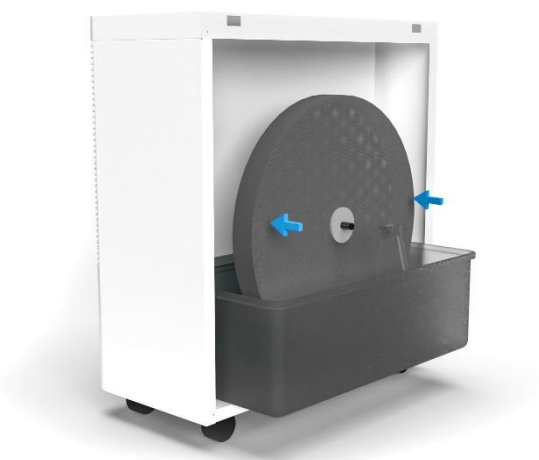

Fig. 4.2.7: Inserting the evaporative filter disc and water tank into the unit

8. Place the evaporation filter disc in the water tank (Fig. 4.2.7) and fold the electrode rods down.

9. Insert the connecting shaft on the back of the filter retainer into the gear motor receptacle in the unit.

10. The water tank can then be pushed in so that the front holder of the filter retainer fits into the filter rack of the water tank.



Fig. 4.2.8: Closing the outlet grille

11. Hook the outlet grille into the holder at the top of the unit (Fig. 4.2.8/1).

12. Close the outlet grille (Fig. 4.2.8/2). The magnets keep the unit housing closed.

13. Reset filter change display to delete error message (👉 see "Menu overview" on page 24).

4.5 Change cleaning filter



WARNING! Danger of electric shock if the mains plug is not pulled out!

Disconnect the unit from the mains before starting.



Fig. 4.5.1: Removing the intake grille

The matching cleaning filters (item no.: 2624) can be obtained from our customer service department (☞ "Customer service" on page 2).

1. Remove the mains cable and, if applicable, the safety pressure hose (only for units with direct water connection).
2. Lift the intake grille on the bottom of the unit. The intake grille of the humidifier is held in place by magnets and a catch on the upper side of the unit.
3. Now slide the intake grille upwards to lift it out of the lock on the unit.

4. Remove the old cleaning filter from the intake grille.
5. Stick the new cleaning filter (item no.: 2624) into the recess provided.



Fig. 4.5.2: Replacing the cleaning filter

6. Refit the intake grille to the unit.

7. To do this, hang the intake grille in the holder at the top of the unit. The magnets on the outer edge of the grille keep the housing closed.



Fig. 4.5.1: Attaching intake grille



5. Menu overview



You can make various settings for your humidifier in the menus.

To do this, switch the device off using the standby button . Now press the standby button  and hold it down for 5 seconds until "Ad" appears on the display .





You can now select the desired menu by pressing the FAN  button. Use the HUMIDITY  and  buttons to change the settings in the respective menus.

The following table gives an overview of the menu structure.

Menu	Description	Settings	Comment	Factory Settings
Ad	Coupling with the radio humidity transmitter		By pressing the HUMIDITY + or - button to select the desired radio coding, see  "Radio humidity transmitter coding" on page 16.	00
b1/b0	Switching the signal tone on and off	b1 = ON b0 = OFF	By pressing the HUMIDITY button you can choose between b1 and b0, see  "Activating/deactivating the signal tone" on page 14.	b1
OF	Readjusting the humidity display	-9% ...+9%	By pressing the HUMIDITY + or - key you can select the desired value, see  "Readjusting the humidity-display" on page 21.	0
FF	Update rate of the internal humidity sensor	0 - 99 = Minutes	By pressing the HUMIDITY + or - button, you can select the desired value.	2
FI*	Number of days until the filter needs to be changed.	0 - 99 = Number of days	After changing the filter, the display must be changed in the menu by pressing the HUMIDITY + or - button so that the error message 03 disappears.	60
CL*	Number of days until the water needs to be changed.	0 - 99 = Number of days	After the water change, the display must be changed in the menu by pressing the HUMIDITY + or - key to make the error message 04 disappear.	30
n9	Reset WLAN/WiFi module	n9 - n0	Press the HUMIDITY + and - buttons simultaneously to start a countdown to reset the settings. ATTENTION: After the countdown is completed, all settings of the WLAN/WiFi module are deleted.	

*Please note that the above mentioned intervals set by us ex works must be adjusted depending on the installation site and duration of use. The intervals can be adjusted based on the conditions given on site in the menu ( see chapter "Select menu" on page 16). If you have any questions, please contact our customer service ( "Customer service" on page 2).

Readjusting the humidity display

With this function you can set a correction value. To do this, select the item "OF" in the special menu using the standby key . Use the HUMIDITY  and  keys to set the value (setting range: -9% ...+9% relative humidity). Once the setting has been made, exit the menu by pressing the standby key .

6. Fix problems

Error code display

If the operation of the humidifier is disturbed, an error message appears in the AIR HUMIDITY %  display field.

Error number	Description	Remedy
F2 / Beep	Tank empty	Refill with water and clean the electrode rods (☞ "Filling the water tank" on page 12).
F4	Internal humidity sensor defective	Contact customer service (☞ "Customer service" on page 2).
03	Filter change necessary	Change the filter (☞ "Changing the evaporative filter" on page 21) + Reset error code (☞ "Menu overview" on page 24).
04	Water change necessary	Change the water. (☞ "Changing the water and cleaning the appliance" on page 21) + Reset error code (☞ "Menu overview" on page 24).
05 / Signal tone	No radio reception (only with radio humidity transmitter, optional accessory)	Check the radio transmitter and change the batteries if necessary (☞ "3.4 Commissioning the radio transmitter" on page 14).
06	Measured value invalid	Contact customer service (☞ "Customer service" on page 2).

Other disturbances	Remedy
Water leakage	<ul style="list-style-type: none"> ■ Pull out the mains plug. ■ Empty the water tank. ■ Check the water tank for damage. ■ Contact customer service (☞ "Customer service" on page 2). ■ Check the correct positioning of the evaporation filter disc (☞ "Changing the evaporation filter" on page 21).
Severe calcification	<ul style="list-style-type: none"> ■ Clean the humidifier more frequently (☞ "Changing water and cleaning the unit" on page 21). ■ Use limescale remover for cleaning (☞ "Changing the water and cleaning the appliance" on page 21).
Odour development	<ul style="list-style-type: none"> ■ Change the water more frequently (☞ "Changing the water and cleaning the appliance" on page 21). ■ Clean the humidifier more frequently (☞ "Changing water and cleaning the unit" on page 21). ■ Use water fresh (☞ "Water fresh" on page 12). ■ Replace the filter (☞ "Replacing the evaporative filter" on page 21).

Repairs

Repairs may only be carried out by the manufacturer's customer service (☞ "Customer service" on page 2) or trained electricians.

7. Spare parts

Here you will find a list of common spare parts and accessories:

Article description	Item no.
Evaporation filter disc B 250 / B 260	2625
Filter retainer evaporative filter disc B 250 / B 260	2450.1
Cleaning filter B 260	2624
Waterfresh 1l bottle	9020
Waterfresh 5l canister	9022
Limescale remover 1000 ml	9016
Fan motor B 260	2500
Gear motor B 260	2589/1
Connecting shaft for filter retainer B 250 / B 260	2449/1
Filter rack water tank B 250 / B 260	2451.1
Water tank B 250 / B 260	2250
Electrode rods B 250 / B 260 with head and cable loom	2587

8. Nameplate

LUFTBEFEUCHTUNG PROKLIMA GMBH
74858 AGLASTERHAUSEN / GERMANY



The name plate contains the following information:

- Manufacturer
- Type
- Series
- Serial number
- Electrical power and connection values

9. Disposal

Unless a take-back or disposal agreement has been made, disassembled components should be recycled:

- Scrap metals.
- Give plastic elements for recycling.
- Dispose of remaining components sorted according to material composition.
- Dispose of batteries at the usual local collection points.
- Have electrical waste and electronic components disposed of by authorised specialist companies.
- In case of doubt, obtain information on environmentally sound disposal from the local municipal authority or specialised disposal companies.



ENVIRONMENTAL PROTECTION!
Danger to the environment due to incorrect disposal!
Incorrect disposal can cause hazards to the environment.



Notes



Luftbefeuchtung Proklima GmbH
Schwarzacher Str. 13
74858 Aglasterhausen
Germany

Tel.: +49 (0) 6262 / 5454
Fax: +49 (0) 6262 / 3255

Mail: mail@brune.info
Web: www.brune.info